

# Expansion and anti-Vibration Products



**Key Points**

- Require Full Guiding
- Available for any Temperature or Pressure
- Supplied with CE Certs where Applicable
- Internal Flow Liner as Standard
- Bellows are Pre-Cold Drawn

**EXCO Type AX2 Axial Bellows**

Designed to accept linear expansion on copper and stainless steel pipe systems. Standard product details are shown below, although these may vary dependant upon application and PED requirements.

**Material Specification**

Flanges: Carbon Steel PN16 With Stainless steel facings  
 (Stainless steel to all wetted areas)  
 Convolutions: 316 Stainless Steel  
 Internal Sleeve: 316 Stainless Steel

**Working Conditions**

Pressure: 16 Bar  
 Temperature: 120 Degrees C  
 Test: 1.5x Working

**PED Requirements**

All Bellows supplied by EXCO are manufactured and certified in accordance with EU PED Legislation and as such carry the relevant CE certification where required.

Size (mm)	Axial Compression (mm)	Installed Length	Effective Area cm <sup>2</sup>	Force to Compress N/mm	Part Number
32nb / 35cu	30	130	14	39	AX2/032/PN16
40nb / 42cu	30	130	20	53	AX2/040/PN16
50nb / 54cu	50	225	32	53	AX2/050/PN16
65nb / 67cu	50	225	49	91	AX2/065/PN16
80nb / 76cu	50	230	66	99	AX2/080/PN16
100nb / 108cu	50	230	124	121	AX2/100/PN16
125nb / 133cu	60	240	180	117	AX2/125/PN16
150nb / 159cu	60	240	262	173	AX2/150/PN16
200nb	70	275	419	179	AX2/200/PN16
250nb	70	280	665	270	AX2/250/PN16
300nb	70	285	909	320	AX2/300/PN16

The anchor loads generated by this type of Axial Expansion Compensator are high. A bracket guide with a low frictional resistance should be used.

Please note these units are not suitable for use on a drop rod system and need to be suitably guided (e.g. EXCO 253 Slide Guide or EXCO 114 Roller Chair and Guide). Please consult the Expansion Compensator Application Guide for positioning of anchor points and subsequent support centres. (See page 116)

**Primary Pipe Guide Spacings**

Anchor Point      Secondary Guide 12 - 14 Pipe od's      Primary Guide 2-4 Pipe od's



## Key Points

- Require Full Guiding
- Available for any Temperature or Pressure
- Supplied with CE Certs where Applicable
- Internal Flow Liner as Standard
- Bellows are Pre-Cold Drawn

### EXCO Type AX3 (SPE) Axial Bellows

Designed to accept linear expansion on Steel & Copper pipe systems.

#### Working Conditions

Pressure: Standard 10 Bar (Upto 16 Bar - Dependant on PED Conditions)  
 Temperature: 120 Degrees C  
 Test: 1.5x Working

#### PED Requirements

All Bellows supplied by EXCO are manufactured and certified in accordance with EU PED Legislation and as such carry the relevant CE certification where required.

Size (mm)	Axial Compression (mm)	Installed Length	Effective Area cm <sup>2</sup>	Force to Compress N/mm	Part Number
15	25	200	4	1.47	AX3/015/SPE(25)
18	25	200	5	1.47	AX3/012/SPE(25)
20	25	200	6	1.47	AX3/020/SPE(25)
25	25	200	10	1.27	AX3/025/SPE(25)
32	25	210	16	3.04	AX3/032/SPE(25)
40	25	220	21	3.04	AX3/040/SPE(25)
50	25	250	40	3.34	AX3/050/SPE(25)

The anchor loads generated by using this type of Axial Expansion Compensator are high. It is worth keeping in mind the type of pipework bracketry that will be used. A guide bracket with a low frictional resistance should be used.

Please note these units are not suitable for use on a drop rod system and need to be suitably guided. Please consult the Expansion Compensator Application Guide for positioning of anchor points and subsequent support centres. (See Page 116)

#### Primary Pipe Guide Spacings





### Key Points

- Require Full Guiding
- Available in any Temperature or Pressure
- Supplied with CE certs where Applicable
- Internal Flow liner as Standard
- Bellows are Pre-Cold Drawn

### Material Specification

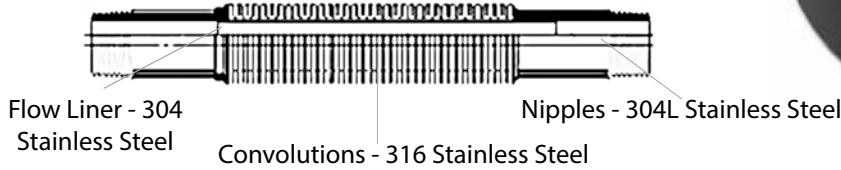

### EXCO Type AX3 Axial Bellows

Designed to accept linear expansion on Steel & Copper pipe systems.

### Working Conditions

Pressure: Standard 10 Bar (Upto 16 Bar - Dependant on PED Conditions)  
 Temperature: 120 Degrees C  
 Test: 1.5x Working

### PED Requirements

All Bellows supplied by EXCO are manufactured and certified in accordance with EU PED Legislation and as such carry the relevant CE certification where required.

Size (mm)	Axial Compression (mm)	Installed Length	Effective Area cm <sup>2</sup>	Force to Compress N/mm	Part Number
15	25	200	4	1.47	AX3/015/MSC(25)
20	25	200	6	1.47	AX3/020/MSC(25)
25	25	200	10	1.27	AX3/025/MSC(25)
32	25	210	16	3.04	AX3/032/MSC(25)
40	25	220	21	3.04	AX3/040/MSC(25)
50	25	250	40	3.34	AX3/050/MSC(25)
65	25	273	50	3.54	AX3/065/MSC(25)
15	50	300	4	1.47	AX3/015/MSC(50)
20	50	300	6	1.47	AX3/020/MSC(50)
25	50	300	10	1.27	AX3/025/MSC(50)
32	50	310	16	3.04	AX3/032/MSC(50)
40	50	320	21	3.04	AX3/040/MSC(50)
50	50	350	40	3.04	AX3/050/MSC(50)

The anchor loads generated by using this type of Axial Expansion Compensator are high. It is worth keeping in mind the type of pipework bracketry that will be used. A guide bracket with a low frictional resistance should be used.

Please note these units are not suitable for use on a drop rod system and need to be suitably guided. Please consult the Expansion Compensator Application Guide for positioning of anchor points and subsequent support centres. (See Page 114)

### Primary Pipe Guide Spacings

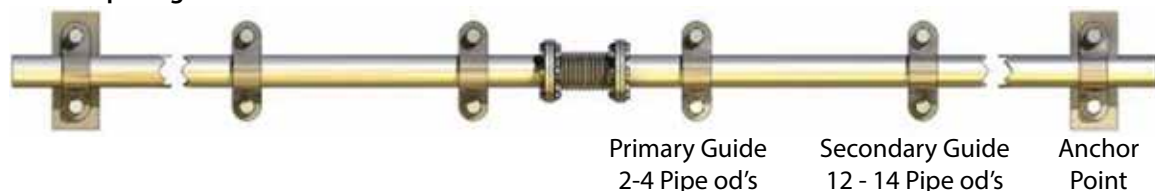

## Key Points



FA1 for steel pipes

FA2 for copper & stainless steel.

Supplied with CE certs where applicable

Internal flow liner as standard

Size	Installed Length +/- 25 (mm)	Force to Deflect +/- 25mm (N/mm)	Installed Length +/- 50 (mm)	Force to Deflect +/- 50 (mm)	Part Number
25	465	10.7	750	2.8	FA1/025/PN16
32	465	10.7	750	2.8	FA1/032/PN16
40	465	10.7	750	2.8	FA1/040/PN16
50	465	12.1	750	4	FA1/050/PN16
65	465	15.9	750	5	FA1/065/PN16
80	465	56.7	750	16	FA1/080/PN16
100	465	94.0	750	27	FA1/100/PN16
125	760	21.6	1000	11	FA1/125/PN16
150	760	38.2	1000	19	FA1/150/PN16
200	1010	29.8	1250	17	FA1/200/PN16
250	1010	55.2	1250	32	FA1/250/PN16

Size	Installed Length +/- 75 (mm)	Force to Deflect +/- 75mm (N/mm)	Installed Length +/- 100 (mm)	Force to Deflect +/- 100 (mm)	Part Number
25	1035	1.3	1320	1.3	FA1/025/PN16
32	1035	1.3	1320	1.3	FA1/032/PN16
40	1035	1.3	1320	1.3	FA1/040/PN16
50	1035	1.7	1320	1.3	FA1/050/PN16
65	1035	2.2	1320	1.3	FA1/065/PN16
80	1035	7.7	1320	2.7	FA1/080/PN16
100	1035	12.3	1320	5.4	FA1/100/PN16
125	1240	4.3	1480	5.4	FA1/125/PN16
150	1240	11.1	1480	4.5	FA1/150/PN16
200	1490	11.5	1730	4.5	FA1/200/PN16
250	1490	22.8	1730	4.5	FA1/250/PN16

### Material Specification

Connections:	Carbon Steel Drilled PN1 6 (Van-stone Facings on FA2)
Convolutions:	321 Stainless Steel (316 Stainless steel on FA2)
Internal Sleeve:	321 Stainless Steel (316 Stainless steel on FA2)
Tie Rods:	Carbon Steel
Hemispherical Washers:	Carbon Steel
Connecting Spool:	Carbon Steel (316 Stainless steel on FA2)

The EXCO Type FA1 & FA2 Lateral Expansion compensator is suitable for use on systems up to 250°C at 16 bar pressure PED certification supplied dependant upon application.

All units are supplied at installation lengths and are pre stressed. Please note EXCO can design and supply lateral expansion compensators to accommodate higher system temperatures / pressures and other rates of lateral movement or special dimensions. Please advise at time of enquiry / order the system temperature and pressure to allow correct selection of compensator.

### Standard Installation

These units are often used when new mains are being connected to existing mains. They allow a lateral movement to occur. These units are also useful for connections from boilers and plant, which will compensate any stresses put onto the "Headers". Advice should always be sought when using these units to ensure the units will allow the amount of movement which will occur. Please consult the Expansion Compensator Application Guide for positioning of the anchor points and subsequent support centres. (See page 114)

### Key Points

AN1 for Steel Pipes

AN2 for Copper & Stainless Steel

Supplied with CE Certs where Applicable

Internal Flow Liner as Standard



Size (mm)	Angular Deflection	Installed Length	Effective Area cm <sup>2</sup>	Force to Deflect Nm/deg	Part Number
25	+/- 5°	195	40	1.27	AN1/025/PN16
32	+/- 5°	195	40	3.04	AN1/032/PN16
40	+/- 5°	200	40	3.04	AN1/040/PN16
50	+/- 5°	133	40	3.34	AN1/050/PN16
65	+/- 5°	133	62	1.47	AN1/065/PN16
80	+/- 5°	133	81	1.47	AN1/080/PN16
100	+/- 5°	133	127	1.27	AN1/100/PN16
125	+/- 6.5°	199	195	3.04	AN1/125/PN16
150	+/- 6.5°	199	273	3.04	AN1/150/PN16
200	+/- 7.5°	212	469	3.34	AN1/200/PN16
250	+/- 7.5°	212	700	3.04	AN1/250/PN16

### Material Specification

Connections: Carbon Steel Drilled PN16 (Van-stone facings on AN2)  
Other Flanges Available If Required

Convolutions: 321 Stainless Steel (316 Stainless steel on AN2)

Internal Sleeve: 321 Stainless Steel (316 Stainless steel on AN2)

Hinge Pins: Carbon Steel

The EXCO Type AN1 & AN2 Angular Expansion compensators are suitable for use on systems up to 200°C at 16 bar pressure. All units are supplied at installation lengths and are pre stressed. Please note EXCO Group can design and supply angular expansion compensators to accommodate higher system temperatures / pressures or special dimensions. Please advise at time of enquiry / order the system temperature and pressure to allow correct selection of compensator.

### PED Requirements

CE Certificates issued if required. All units are categorised to PED standards, and we require accurate temperatures and pressures at time of order to enable correct selection and certification.

### Standard Installation

These units are commonly used in pairs, although three pin systems can be designed if required. Please contact our sales office for application and design advice. These units can be used on a drop rod system. Please consult the Expansion Compensator Application Guide for positioning of anchor points. (See page 114)

## Key Points



GI1 for Steel Pipes

GI2 for Copper & Stainless Steel

Supplied with CE Certs where Applicable

Internal Flow Liner as Standard

Size (mm)	Angular Deflection	Installed Length	Force to Deflect Nm/deg	Part Number
25	+/- 5°	195	8.3	GI1/025/PN16
32	+/- 5°	195	8.3	GI1/032/PN16
40	+/- 5°	195	8.3	GI1/040/PN16
50	+/- 5°	180	8.3	GI1/050/PN16
65	+/- 5°	180	10.1	GI1/065/PN16
80	+/- 5°	180	31.4	GI1/080/PN16
100	+/- 5°	180	60.8	GI1/100/PN16
125	+/- 6.5°	225	36.2	GI1/125/PN16
150	+/- 6.5°	225	55.3	GI1/150/PN16
200	+/- 7.5°	250	107.1	GI1/200/PN16
250	+/- 7.5°	250	192	GI1/250/PN16

### Material Specification

Connections:	Carbon Steel Drilled PN16 (Van-stone facings on GI2) Other Flanges Available If Required
Convolutions:	321 Stainless Steel (316 Stainless steel on GI2)
Internal Sleeve:	321 Stainless Steel (316 Stainless steel on GI2)
Hinge Pins:	Carbon Steel

The EXCO Type GI1 & GI2 Gimbal Expansion compensators are suitable for use on systems up to 200°C at 16 bar pressure. All units are supplied at installation lengths and are pre stressed.

Please note EXCO can design and supply gimbal expansion compensators to accommodate higher system temperatures / pressures or special dimensions. Please advise at time of enquiry / order the system temperature and pressure to allow correct selection of compensator.

### PED Requirements

CE Certificates issued if required. All units are catagorised to PED standards, and we require accurate temperatures and pressures at time of order to enable correct selection and certification.

### Standard Installation

These units are commonly used in pairs, although three pin systems can be designed if required. Please contact our sales office for application and design advice. These units can be used on a drop rod system. (See page 114)

## Key Points

Flanges: Carbon Steel - Drilled PN16 or PN6  
(Other Flanges Available )

Nylon Re-inforced EPDM Rubber Body

Steel Reinforced Collars

Round flanges - No Tie Bars



Size (mm)	Installed Length	Material Type	Temperature Limits °C	Part Number
32	130	Nylon Reinforced EPDM	-10 - 90	EXCO/032/PN16/6
40	130	Nylon Reinforced EPDM	-10 - 90	EXCO/040/PN16/6
50	130	Nylon Reinforced EPDM	-10 - 90	EXCO/050/PN16/6
65	130	Nylon Reinforced EPDM	-10 - 90	EXCO/065/PN16/6
80	130	Nylon Reinforced EPDM	-10 - 90	EXCO/080/PN16/6
100	130	Nylon Reinforced EPDM	-10 - 90	EXCO/100/PN16/6
125	130	Nylon Reinforced EPDM	-10 - 90	EXCO/125/PN16/6
150	130	Nylon Reinforced EPDM	-10 - 90	EXCO/150/PN16/6

EXCO D-Flex Pump Flexibles are installed to absorb vibration and noise levels caused by “Plant” upon which they are fitted. These are suitable for use on systems carrying Chilled & Heating Water. Please see above for temperature & Pressure limits.

EXCO D Flex units are not suitable for use with Potable Water, Water with Oil additives, Compressed Air and Food Applications.

EXCO D Flex Untied units should not be installed on pumps located on Inertia bases

EXCO D-Flex units are manufactured from spherical moulded EPDM, which is a soft compound to offer a high isolation efficiency and high noise absorbing properties.

EXCO The units are a full bore thus removing pressure drop problems. The EPDM rubber is nylon re-inforced, and has a steel wire re-inforced collar.

Flanges BZP coated carbon steel PN16.

D-Flex units have a 10 year design life when used on LTHW systems.

EXCO D Flex units are stamped with Origin of Manufacture, Date Of Manufacture, Batch Number and Size.

Please note no torsion forces should be applied to these units.

EXCO also Supply DIN 4809 Approved Pump Flexibles. Please Contact our Sales Office for further information.



## Key Points



Flanges: Carbon Steel - Drilled PN16  
(Other Flanges Available)

Nylon Re-inforced EPDM Rubber Body

Steel Reinforced Collars

Tie Bars: Anti-Tamper Carbon Steel

Size (mm)	Installed Length	Material Type	Temperature Limits °C	Part Number
32	130	Nylon Reinforced EPDM	-10 - 90	EXCO/032/PN16T
40	130	Nylon Reinforced EPDM	-10 - 90	EXCO/040/PN16T
50	130	Nylon Reinforced EPDM	-10 - 90	EXCO/050/PN16T
65	130	Nylon Reinforced EPDM	-10 - 90	EXCO/065/PN16T
80	130	Nylon Reinforced EPDM	-10 - 90	EXCO/080/PN16T
100	130	Nylon Reinforced EPDM	-10 - 90	EXCO/100/PN16T
125	130	Nylon Reinforced EPDM	-10 - 90	EXCO/125/PN16T
150	130	Nylon Reinforced EPDM	-10 - 90	EXCO/150/PN16T
200	130	Nylon Reinforced EPDM	-10 - 90	EXCO/200/PN16T
250	130	Nylon Reinforced EPDM	-10 - 90	EXCO/250/PN16T
300	On Request	Nylon Reinforced EPDM	-10 - 90	EXCO/300/PN16T
350	On Request	Nylon Reinforced EPDM	-10 - 90	EXCO/350/PN16T
400	On Request	Nylon Reinforced EPDM	-10 - 90	EXCO/400/PN16T

EXCO D-Flex Pump Flexibles are installed to reduce Vibration and noise levels caused by "Plant" upon which they are fitted. These are suitable for use on systems carrying Chilled & Heating Water. Please see above for temperature & Pressure limit. EXCO D-Flex units are not suitable for use with Potable Water, Water with Oil additives, Compressed Air and Food Applications.

EXCO D-Flex units are manufactured from spherical moulded EPDM, which is a soft compound to offer a high isolation efficiency and high noise absorbing properties.

The D-flex units tied type has specially designed anti tamper tie bars. This will only allow the units to be installed at their optimal length and avoid elongation of the unit. These units are 16 bar rated.

The units are a full bore thus removing pressure drop problems.

The EPDM rubber is nylon re-inforced, and has a steel wire re-inforced collar.

Flanges BZP coated carbon steel PN16.

D-Flex units have a 10 year design life when used on LTHW systems.

EXCO D Flex units are stamped with Origin of Manufacture, Date Of Manufacture, Batch Number and Size.

Please note no torsion forces should be applied to these units.

EXCO also supply DIN 4809 Approved Pump Flexibles. Please contact our sales office for further information.

## Key Points

Unions: Carbon Steel

Nylon Re-inforced EPDM Rubber Body

Steel Reinforced Collars



Size (mm)	Installed Length	Material Type	Temperature Limits °C	Part Number
15	200	Nylon Reinforced EPDM	-10 - 90	PGS/015
20	200	Nylon Reinforced EPDM	-10 - 90	PGS/020
25	200	Nylon Reinforced EPDM	-10 - 90	PGS/025
32	200	Nylon Reinforced EPDM	-10 - 90	PGS/032
40	200	Nylon Reinforced EPDM	-10 - 90	PGS/040
50	200	Nylon Reinforced EPDM	-10 - 90	PGS/050

EXCO D-Flex Pump Flexibles are installed to absorb vibration and noise levels caused by "Plant" upon which they are fitted. These are suitable for use on systems carrying Chilled & Heating Water. Please see above for temperature & Pressure limits.

EXCO D Flex units are not suitable for use with Potable Water, Water with Oil additives, Compressed Air and Food Applications.

EXCO D Flex Untied units should not be installed on pumps located on Inertia bases

EXCO D-Flex units are manufactured from spherical moulded EPDM, which is a soft compound to offer a high isolation efficiency and high noise absorbing properties.

The units are a full bore thus removing pressure drop problems. The EPDM rubber is nylon re-inforced, and has a steel wire re-inforced collar.

Unions BZP coated carbon steel PN16.

D-Flex units have a 10 year design life when used on LTHW systems.

EXCO D Flex units are stamped with Origin of Manufacture, Date Of Manufacture, Batch Number and Size.

Please note no torsion forces should be applied to these units.

EXCO also supply DIN 4809 approved pump flexibles. Please contact our sales office for further information.

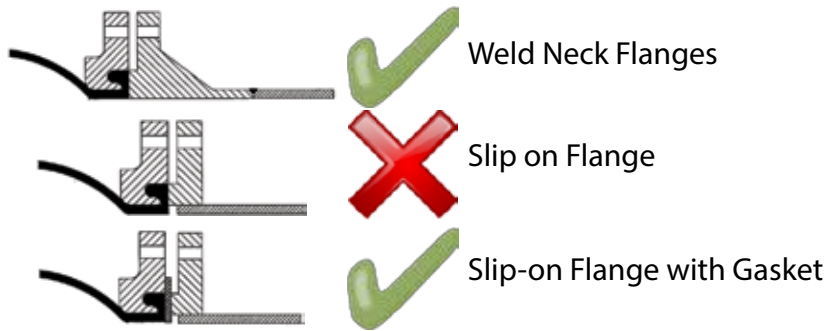

## A. Pre-installation Check

### 1. Selection

Prior to installation, check you have the right bellows for the particular duty.

Rubber bellows have temperature and pressure limitations. See EXCO Data Sheets for your product.

All rubber bellows will extend under pressure. These pressure thrust forces can be very substantial at pressures above 2 bar and 65mm N.B. size. Unless the pipe work can be sufficiently anchored a tied bellows should be fitted.

### 2. Mating Flanges

We recommend the rubber bellows are mated up against full-bore weld neck flanges. If installed in this manner no additional gaskets are required.

We advise against using slip on or screwed flanges as mating flanges, as these can damage the rubber bellows. Once the sealing face has been damaged medium, will penetrate the reinforcement layers and destroy the integrity of the bellows.

If it is unavoidable to use this type of mating flange, a gasket must be installed. (This should be a hard gasket such as Klingerite and be at least 3mm thick) The gasket should reach the internal bore of the rubber bellows. Another option is to fill the gap of the slip on flange with weld and grind it flush.

### 3. Misalignment

Check the two mating flanges are parallel and that they are in line (maximum allowed offset is 5mm in any direction). The gap between flanges should be within +/- 5mm of the bellows neutral. Under no circumstances must the Pump Flexible be used to take up misalignment.

Ensure the pipework is adequately supported. The bellows must not support pipes or plant.

## B. Installation

### 1. Bolts

Bolts should be inserted from the bellows side. On some larger sizes this may not be possible. In that case a bolt of the exact length needs to be selected. An alternative is to use studding cut to length and fitted with a nut at both sides. This is important, as the bellows will increase in diameter under pressure. Even if there is space between the bolt and the bellows in an un-pressurised state, they may foul when pressurised. Bolts of the right diameter must be used to ensure correct alignment.

### 2. Alignment

Take care when inserting the bellows into the gap between the two mating flanges. Sharp edges can damage the sealing face of the rubber bellows. Before tightening the bolts, ensure the bellows sits evenly in its flange groove and does not get pinched between flanges. The sealing face of the bellows must be concentric with the sealing face of the mating flanges.

### 3. Tightening the Bolts

Great care has to be taken with the tightening of the flange bolts. Remember you are tightening against a rubber face. As with gaskets, over tightening will cause the joints to leak and it will damage the bellows. "Tighter is definitely not better!"

Tighten opposite bolts to get an even pressure all round (check the gap between the flanges).

Rubber will set and the bolts will have to be retightened after 24 hours.

### 4. Tie Bars

Once the bellows is fitted, ensure the tie bars are tight. All tie bars should be at equal length. When three or more tie bars are fitted it may be necessary to remove one tie bar to install the bellows. Ensure that washers are re-assembled in the right order and orientation.

## C. Taking Care of Rubber Bellows

1. Paint - Do not paint rubber bellows. The paint will attack the rubber. (This also applies to paint splatter).
2. Welding - Protect the rubber from weld spatter.
3. Lagging - Do not Lag rubber bellows on heating systems. The increased temperature will reduce the life of the bellows.
4. Tie Bar Check - Once the system is filled but not under pressure, check the tie bars are still tight (pipe work on springs may have dropped due to the weight of the water).  
  
Note: - tie bars should never be slackened off to reduce noise or vibration transmission, major damage to equipment may occur.
5. Water Treatment - Most bellows use an EPDM inner liner. EPDM is a proven material in heating and chilled water systems. It is resistant to glycol and to most chemicals used in water treatment, when used in normal concentrations. Suppliers of water treatment chemicals are reluctant to give information about their formulations, we cannot approve any specific chemical.

Always check with the chemical supplier that the additives are suitable for use with EPDM rubber. For other mediums check with EXCO for suitability.

## D. Best Practice

The following are only recommendations but if followed they will ensure proper installation and maximum service life of the rubber bellows.

1. Fitting - We recommend the use of stool pieces to align mating flanges and to ensure the correct gap. (They are available from EXCO).
2. System - When the bellows are installed on rotating equipment such as pumps to absorb noise and vibration, the pipe work either side of the bellows should be guided. This ensures the bellows move and not the pipe work thus acting as an acoustic break.



### Key Points

- Suitable for Potable Water
- Suitable for High Temperatures
- PED Certified as Required
- Stainless Steel to all Wetted Areas

Size (mm)	Installed Length	Material Type	Temperature Limits °C	Part Number
32nb / 35cu	150	316 St/Steel to all Wet Areas	-10 - 200	FA3/032/PN16T
40nb / 42cu	150	316 St/Steel to all Wet Areas	-10 - 200	FA3/040/PN16T
50nb / 54cu	150	316 St/Steel to all Wet Areas	-10 - 200	FA3/050/PN16T
65nb / 67cu	150	316 St/Steel to all Wet Areas	-10 - 200	FA3/065/PN16T
80nb / 76cu	150	316 St/Steel to all Wet Areas	-10 - 200	FA3/080/PN16T
100nb / 108cu	150	316 St/Steel to all Wet Areas	-10 - 200	FA3/100/PN16T
125nb / 133cu	150	316 St/Steel to all Wet Areas	-10 - 200	FA3/125/PN16T
150nb / 159cu	150	316 St/Steel to all Wet Areas	-10 - 200	FA3/150/PN16T
200nb	150	316 St/Steel to all Wet Areas	-10 - 200	FA3/200/PN16T
250nb	On Request	316 St/Steel to all Wet Areas	-10 - 200	FA3/250/PN16T
300nb	On Request	316 St/Steel to all Wet Areas	-10 - 200	FA3/300/PN16T
350nb	On Request	316 St/Steel to all Wet Areas	-10 - 200	FA3/350/PN16T
400nb	On Request	316 St/Steel to all Wet Areas	-10 - 200	FA3/400/PN16T

EXCO D-Flex Pump Flexibles are installed to reduce Vibration and noise levels caused by "Plant" upon which they are fitted. These are suitable for use on systems carrying high temperature water or potable water systems. Please see above for temperature & Pressure limits. EXCO FA3 units are suitable for use with Potable Water, Water with Oil additives, Compressed Air and Food Applications.

### Material Specification

Connections:	Carbon Steel Drilled PN1 6 Van-stone Facings
Convolutions:	316 Stainless steel
Internal Sleeve:	316 Stainless steel
Tie Rods:	Carbon Steel
Hemispherical Washers:	Carbon Steel
Connecting Spool:	316 Stainless steel

The EXCO Type FA3 Pump Flexible is suitable for use on systems up to 200oC at 16 bar pressure. PED certification supplied dependant upon application.

All units are supplied at installation lengths and are pre stressed. Please note, EXCO can design and supply flexible connections to accommodate higher system temperatures / pressures. Please advise at time of enquiry / order the system temperature and pressure to allow correct selection of compensator.

## Key Points

EPDM Rubber Core

304 Stainless Steel Overbraid

Hose WRAS Approved

Manufactured by EXCO in the UK

0 - 100oC @ 10 Bar



- Description - EPDM Rubber hose with 304 Stainless steel overbraid, swaged fittings to clients requirements.
- Testing - Hydrostatic batch test to minimum 20 bar cold. Test Certificate can be submitted upon request.
- Approvals - All hose is WRAS approved irrespective of application.
- Applications - Fan Coil Connections  
Radiant Panel Connections  
Tap Connections

## Fittings

**FIT001**  
Fixed Taper Male



**FIT006**  
Flat Face 90° Female Elbow



**FIT002**  
Swivel Flat Face Female



**FIT007**  
Coned Face 90° Female Elbow



**FIT003**  
Swivel Coned Seat Female

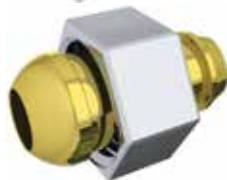

**FIT008**  
Plastic Push Fit (Brass Push Fit Available on Request)



**FIT004**  
Compression



**FIT009**  
Flat Faced Insert with Retained Washer



**FIT005**  
Brass Standpipe



**FIT0010**  
Long Tap Tail (Also Available Short Tail)



## Key Points

321 Stainless Steel Core

304 Stainless Steel Overbraid

Manufactured in the UK

0 - 100oC @ 10 Bar



- Description - 321 Stainless steel hose with 304 Stainless steel overbraid. Welded fittings to client requirements.
- Testing - Hydrostatic batch test to minimum 20 bar cold. Test Certificate can be submitted upon request.
- Applications -
  - Fan Coil Connections
  - Radiant Panel Connections
  - Tap Connections
  - Final Connections to Equipment

## ■ Fittings

**FIT001**  
Fixed Taper Male



**FIT006**  
Flat Face 90° Female Elbow



**FIT002**  
Swivel Flat Face Female



**FIT007**  
Coned Face 90° Female Elbow



**FIT003**  
Swivel Coned Seat Female



## Key Points

10 Year Guarantee for EPDM. 2 Year Gaurentee for Stainless Steel

25 Year Design Life

ISO9001 Quality System

Manufactured at EXCO in the UK



## Installation

Installation conditions as below must be adhered to, to ensure longevity of the product.

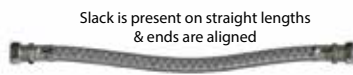

Avoid bending radius becoming too small by using elbows



Hose is long enough to allow smooth curve



Do not bend hose too close to crimped end



Observe minimum bend radius

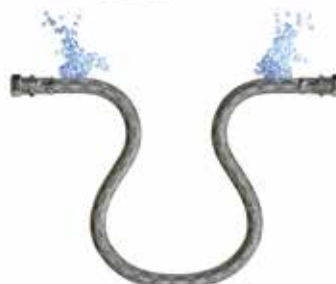



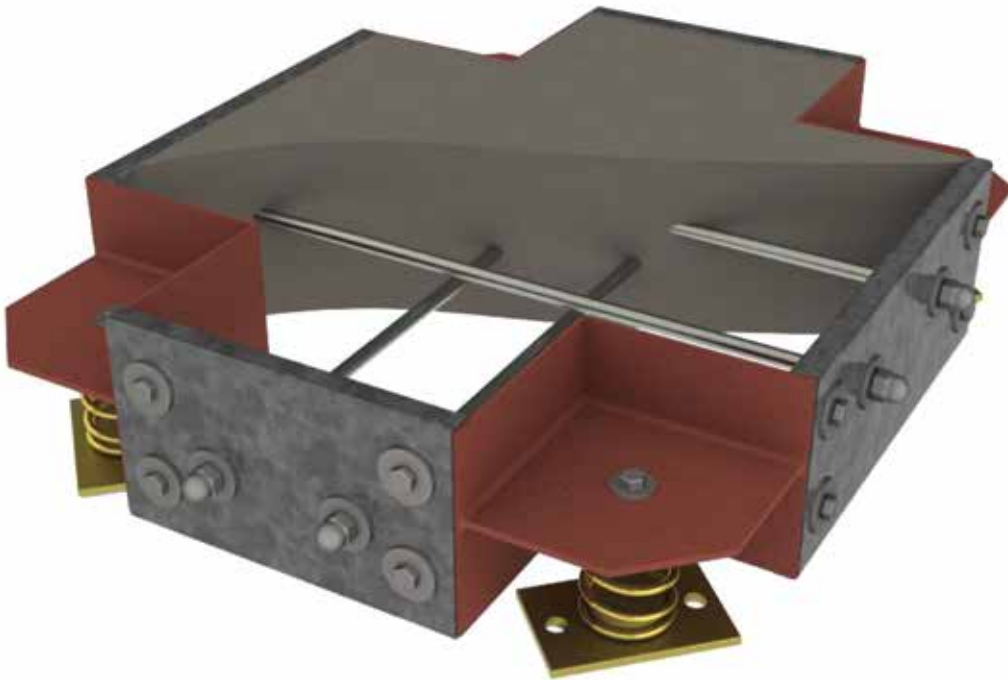

- EXCO Inertia Bases are supplied in a flat pack form to allow ease of installation on site, but can be delivered assembled if required. These are supplied with spring mounts and all fixings required to assemble the inertia base.
- EXCO can calculate the size of inertia base required. Please forward the pump details to DST Group Sales Office. As standard the EXCO Inertia Bases are supplied either 150mm or 300mm deep.
- EXCO Inertia Bases are supplied to provide no less than 1.5 : 1.0 Rate of inertia. As standard these bases are supplied with Springs.
- EXCO can, if required supply these bases fully assembled and cast with a 24N mix of concrete.
- EXCO advise that EXCO/\*\*\*/PN16T Tied EXCO D-Flex Pump Flexibles are used for isolating vibration from pump connections.

### **Please Note:**

Spring selection should be based upon equipment weight - EXCO can advise on selection at time of ordering.

Plant and pipework can be loaded unevenly, therefore different spring loads maybe required at different locations - Again EXCO can advise on selection at time of ordering.

Standard springs and housings are BZP with yellow passivate, othercoatings can be offered for external use. Please advise if your application is external.

Springs when fitted should be loaded equally, installing one spring before another will lead to uneven load.

## Key Points

Anti-Vibration Mount for Plant & Machinery

Enclosed Spring for Greater Stability.

Standard 25mm Deflection

Can be used in Conjunction with Inertia Bases



Model	Overall Width (mm)	Bolt Centres (mm)	Bolt Ø	Fixing Bolt Ø	Weight Range (Kg)	Deflection (mm)
DS/0-0050	130	110	M10	M12	11-23	25
DS/0-0080	130	110	M10	M12	18-37	25
DS/0-0130	130	110	M10	M12	30-60	25
DS/0-0200	130	110	M10	M12	45-91	25
DS/0-0300	130	110	M10	M12	68-137	25
DS/0-0500	130	110	M10	M12	114-228	25
DS/0-0630	130	110	M10	M12	148-296	25
DS/0-0800	130	110	M10	M12	182-364	25
DS/1-0150	173	148	M12	M12	34-69	25
DS/1-0200	173	148	M12	M12	45-91	25
DS/1-0300	173	148	M12	M12	68-137	25
DS/1-0500	173	148	M12	M12	114-228	25
DS/1-0750	173	148	M12	M12	170-341	25
DS/1-1000	173	148	M12	M12	227-455	25
DS/1-1200	173	148	M12	M12	273-546	25
DS/1-1400	173	148	M12	M12	318-637	25
DS/1-2-1700	173	148	M12	M12	386-773	25
DS/1-2-1900	173	148	M12	M12	432-864	25

## Please Note

Spring selection should be based upon equipment weight - EXCO can advise on selection at time of ordering.

Plant and pipework can be loaded unevenly, therefore different spring loads maybe required at different locations - EXCO can advise on selection at time of ordering.

Standard housing is powder coated, the standard spring is BZP, other coatings can be offered for external use. Please advise if your application is external.

Springs when fitted should be loaded equally, installing one spring before another will lead to uneven load.

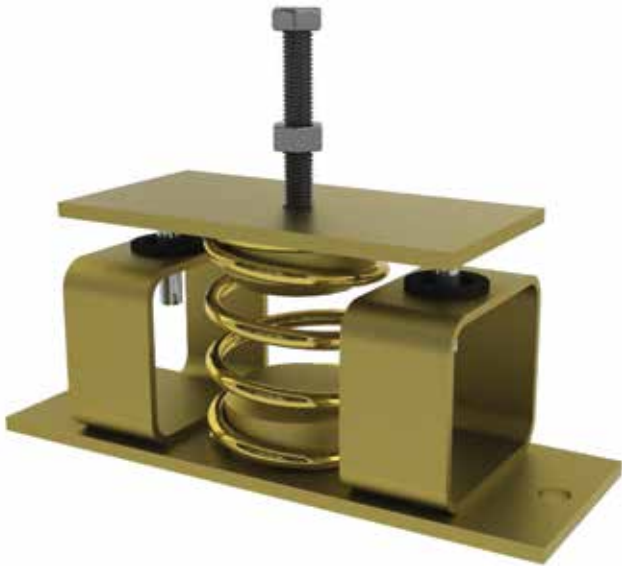

## Key Points

2 Year Guarantee

25 Year Design Life

ISO9001 Quality System

Manufactured in the UK

Model	Overall Width (mm)	Bolt Centres (mm)	Bolt Ø	Fixing Bolt Ø	Weight Range (Kg)	Deflection (mm)
RS/0-0050	230	198	M12	M12	11-23	30
RS/0-0080	230	198	M12	M12	18-37	30
RS/0-0130	230	198	M12	M12	30-60	30
RS/0-0200	230	198	M12	M12	45-91	30
RS/0-0300	230	198	M12	M12	68-137	30
RS/0-0500	230	198	M12	M12	114-228	30
RS/0-0630	230	198	M12	M12	148-287	30
RS/0-0800	230	198	M12	M12	182-364	30
RS/0-1100	230	198	M12	M12	250-500	30
RS/1-0425	230	198	M12	M12	97-194	30
RS/1-0600	230	198	M12	M12	136-273	30
RS/1-0750	230	198	M12	M12	170-341	30
RS/1-1000	230	198	M12	M12	227-455	30
RS/1-1400	230	198	M12	M12	318-637	30
RS/1-1700	230	198	M12	M12	386-773	30
RS/1-2000	230	198	M12	M12	455-910	30
RS/1-2400	230	198	M12	M12	545-1091	30

### Please Note:

Spring selection should be based upon equipment weight - EXCO can advise on selection at time of ordering.

Plant and pipework can be loaded unevenly, therefore different spring loads maybe required at different locations - EXCO can advise on selection at time of ordering.

Standard springs and housings are BZP with yellow passivate, other coatings can be offered for external use. Please advise if your application is external.

Springs when fitted should be loaded equally, installing one spring before another will lead to uneven load.

## Key Points

2 Year Guarantee

25 Year Design Life

ISO9001 Quality System

Manufactured in the UK



Model	Overall Width (mm)	Bolt Centres (mm)	Bolt Ø	Fixing Bolt Ø	Weight Range (Kg)	Deflection (mm)
OS/0-0050	130	92	M12	M10	11-23	30
OS/0-0080	130	92	M12	M10	18-37	30
OS/0-0130	130	92	M12	M10	30-60	30
OS/0-0200	130	92	M12	M10	45-91	30
OS/0-0300	130	92	M12	M10	68-137	30
OS/0-0500	130	92	M12	M10	114-228	30
OS/0-0630	130	92	M12	M10	148-287	30
OS/0-0800	130	92	M12	M10	182-364	30
OS/0-1100	130	92	M12	M10	250-500	30
OS/1-0425	165	120	M12	M12	97-194	30
OS/1-0600	165	120	M12	M12	136-273	30
OS/1-0750	165	120	M12	M12	170-341	30
OS/1-1000	165	120	M12	M12	227-455	30
OS/1-1400	165	120	M12	M12	318-637	30
OS/1-1700	165	120	M12	M12	386-773	30
OS/1-2000	165	120	M12	M12	455-910	30
OS/1-2400	165	120	M12	M12	545-1091	30

## Please Note:

Spring selection should be based upon equipment weight - EXCO can advise on selection at time of ordering.

Plant and pipework can be loaded unevenly, therefore different spring loads maybe required at different locations - EXCO can advise on selection at time of ordering.

Standard springs and housings are BZP with yellow passivate, other coatings can be offered for external use. Please advise if your application is external.

Springs when fitted should be loaded equally, installing one spring before another will lead to uneven load.

## Neoprene Mount

### Key Points



Suitable for isolating vibration from packaged units

Pressurisation Units

Please advise the weight and plant footprint requiring isolation for mount recommendations

Weight (Kg)	Material Type	Hole Tapping Size	Dimensions (mm) Width x Height	Part Number
150	Neoprene Commercial Grade Black Rubber	M10	75 x 32	CMC/150/M
300	Neoprene Commercial Grade Black Rubber	M12	90 x 40	CMC/300/M

## Neoprene Hanger

### Key Points



Isolating vibration from Pipework

Please advise the weight of plant requiring isolation for hanger recommendations

Weight (Kg)	Material Type	Hole Tapping Size	Dimensions (mm) Width x Height	Part Number
150	Neoprene Commercial Grade Black Rubber	M10	75 x 32	CMC/150/M
300	Neoprene Commercial Grade Black Rubber	M12	90 x 40	CMC/300/M

### Please Note:

Mount selection should be based upon equipment weight - EXCO can advise on selection at time of ordering.

Plant and pipework can be loaded unevenly, therefore different mount loads maybe required at different locations - Again EXCO can advise on selection at time of ordering.

Mounts when fitted should be loaded equally, installing one mount before another will lead to uneven load.

## Key Points

2 Year Guarantee

25 Year Design Life

ISO9001 Quality System

Manufactured in the UK



Model	Overall Width (mm)	Bolt Centres (mm)	Bolt Ø	Fixing Bolt Ø	Weight Range (Kg)	Deflection (mm)
SHO S/0-0050	150	180	M12	M12	11-23	30
SHO S/0-0080	150	180	M12	M12	18-37	30
SHO S/0-0130	150	180	M12	M12	30-60	30
SHO S/0-0200	150	180	M12	M12	45-91	30
SHO S/0-0300	150	180	M12	M12	68-137	30
SHO S/0-0500	150	180	M12	M12	114-228	30
SHO S/0-0630	150	180	M12	M12	148-287	30
SHO S/0-0800	150	180	M12	M12	182-364	30
SHO S/0-1100	150	180	M12	M12	250-500	30
SHO S/1-0425	250	250	M16	M16	97-194	30
SHO S/1-0600	250	250	M16	M16	136-273	30
SHO S/1-0750	250	250	M16	M16	170-341	30
SHO S/1-1000	250	250	M16	M16	227-455	30
SHO S/1-1400	250	250	M16	M16	318-637	30
SHO S/1-1700	250	250	M16	M16	386-773	30
SHO S/1-2000	250	250	M16	M16	455-910	30
SHO S/1-2400	250	250	M16	M16	545-1091	30

## Please Note:

Spring selection should be based upon equipment weight - EXCO can advise on selection at time of ordering.

Plant and pipework can be loaded unevenly, therefore different spring loads maybe required at different locations - EXCO can advise on selection at time of ordering.

Standard springs and housings are BZP with yellow passivate, other coatings can be offered for external use. Please advise if your application is external.

Springs when fitted should be loaded equally, installing one spring before another will lead to uneven load.

## Key Points

2 Year Guarantee

25 Year Design Life

ISO9001 Quality System

Manufactured in the UK



Model	Overall Width (mm)	Bolt Centres (mm)	Bolt Ø	Fixing Bolt Ø	Weight Range (Kg)	Deflection (mm)
SHOS/0/P-0050	150	180	M12	M12	11-23	30
SHOS/0/P-0080	150	180	M12	M12	18-37	30
SHOS/0/P-0130	150	180	M12	M12	30-60	30
SHOS/0/P-0200	150	180	M12	M12	45-91	30
SHOS/0/P-0300	150	180	M12	M12	68-137	30
SHOS/0/P-0500	150	180	M12	M12	114-228	30
SHOS/0/P-0630	150	180	M12	M12	148-287	30
SHOS/0/P-0800	150	180	M12	M12	182-364	30
SHOS/0/P-0110	150	180	M12	M12	250-500	30
SHOS/1/P-0425	250	250	M16	M16	97-194	30
SHOS/0/P-0600	250	250	M16	M16	136-273	30
SHOS/1/P-0750	250	250	M16	M16	170-341	30
SHOS/1/P-1000	250	250	M16	M16	227-455	30
SHOS/1/P-1400	250	250	M16	M16	318-637	30
SHOS/1/P-1700	250	250	M16	M16	386-773	30
SHOS/1/P-2000	250	250	M16	M16	455-910	30
SHOS/1/P-2400	250	250	M16	M16	545-1091	30

### Please Note:

Spring selection should be based upon equipment weight - EXCO can advise on selection at time of ordering.

Plant and pipework can be loaded unevenly, therefore different spring loads maybe required at different locations - EXCO can advise on selection at time of ordering.

Standard springs and housings are BZP with yellow passivate, other coatings can be offered for external use. Please advise if your application is external.

Springs when fitted should be loaded equally, installing one spring before another will lead to uneven load.